

OMIT



SERIE **APM-110 BAR** SERIES

Filtri in linea a media pressione
In line filter medium pressure

Con il fine di migliorare costantemente la qualità dei nostri prodotti, ci riserviamo il diritto di modificarne in qualsiasi momento le caratteristiche senza preavviso.
È responsabilità della rispettabile clientela la costante verifica dei dati contenuti nei cataloghi.
Questo catalogo annulla e sostituisce i precedenti.

In order to constantly improve our products quality, we take the right to make changes to the catalogues at any time without notice.
Customers have the responsibility to continuously check all the information in the catalogues.
This catalogue cancels and replaces the previous ones.

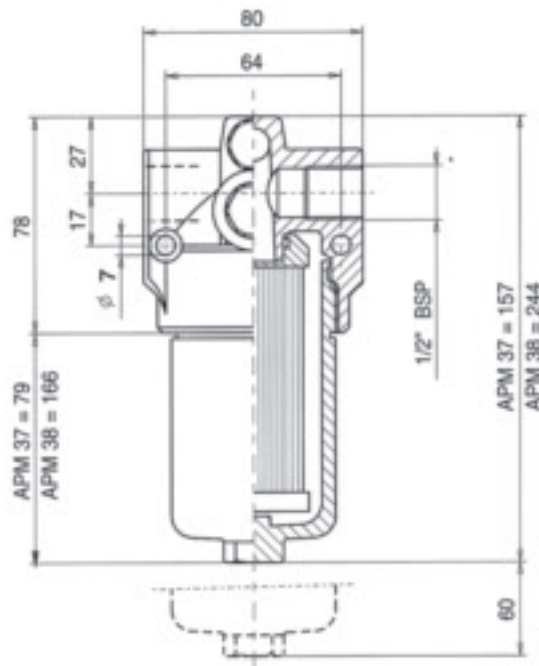

Tipo Type	Portata max Max delivery l/min	Superficie filtrante / Filtration surface dm ²								Peso Weight g
		A	B	C	F	G	H	L	M	
APM 37	60	2,4	2,4	3,14	3,36	3,36	3,36	3,14	3,14	950
APM 38	90	4,95	4,95	6,42	6,88	6,88	6,88	6,42	6,42	1250

INDICATORI DI INTASAMENTO / DIFFERENTIAL INDICATORS

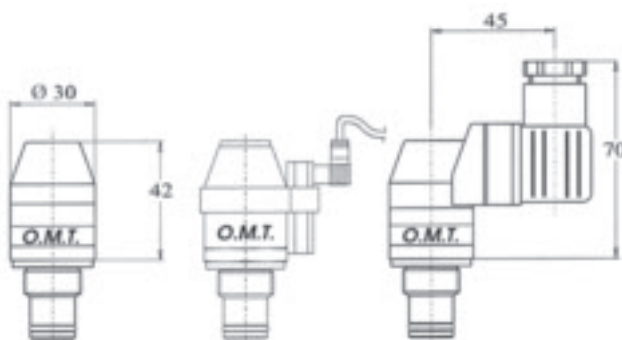

DV500M / DV500
Indicatore visivo
Visual indicator

DR500M / DR500
Indicatore visivo
con contatti "Reed"
Visual indicator
with "Reed" contacts

DE500M / DE500
Indicatore visivo
elettrico
Electrical visual
indicator

Contatti in scambio con i seguenti valori
Exchange contacts with the following values:

Tensione di aliment. Voltage supply (V)	Carico resistivo Resistive charge (A)	Carico induttivo Inductive charge (A)
C.A. 125	5	5
C.A. 250	5	5
C.C. 15	10	10
C.C. 30	5	5
C.C. 50	1	1
C.C. 125	0.5	0.06

Gli indicatori visivi sono disponibili:

- con filettatura M20x1.5 (DV...M) e filettatura 1/2" BSP (DV...)
- con contatti ad ampolla "Reed" (DR131M e DR131)

Visual indicators are available:

- with threads M20x1.5 (DV...M) and threads 1/2" BSP (DV...)
- with "Reed" contacts (DR131M and DR131)

SIMBOLOGIA / SYMBOLS

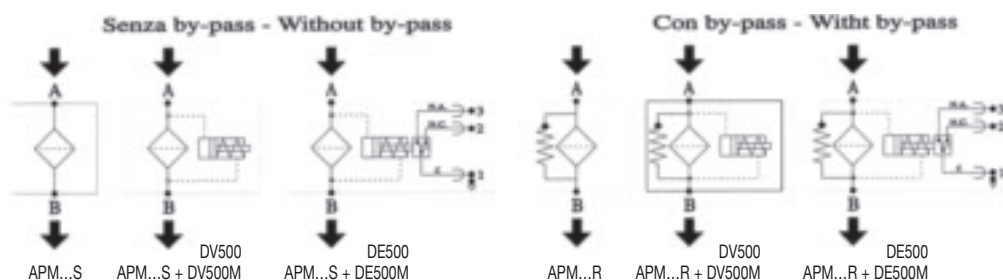

DIAGRAMMA

La caduta di pressione completa si ottiene sommando la caduta di pressione del corpo filtro e quella dell'elemento filtrante.

CADUTA DI PRESSIONE DELLA VALVOLA BY-PASS PRESSURE DROP IN BY-PASS VALVE

Cadute di pressione nel corpo filtro

Le curve sono valide con olio minerale avente massa volumica di 860 kg/m^3 . La caduta di pressione è proporzionale alla massa volumetrica.

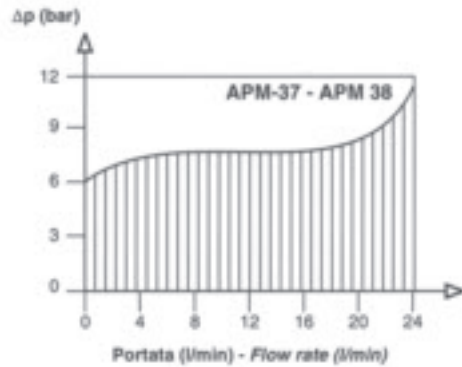

DIAGRAMS

The pressure drop of the complete filter is calculated by adding the pressure drop of the housing to that of the filter element.

CADUTA DI PRESSIONE DEL CORPO FILTRO FILTER HOUSING PRESSURE DROP

Pressure drop in the housing

The graphics refer to use of mineral oil with a mass density of 860 kg/m^3 . The pressure drop is proportional to the variations of mass density.

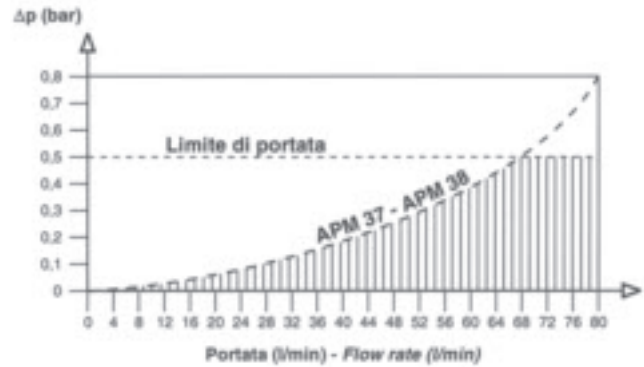

CADUTA DI PRESSIONE DEGLI ELEMENTI FILTRANTI

Cadute di pressione negli elementi filtranti

Le curve sono valide con olio minerale avente viscosità cinematica di 30 cSt. La variazione di caduta di pressione è proporzionale alla viscosità cinematica.

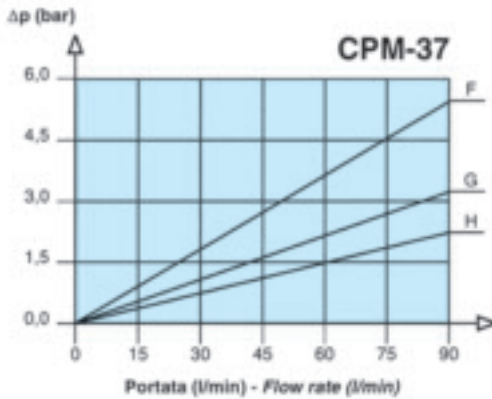

FILTER ELEMENT PRESSURE DROP

Pressure drop in the filtering elements

The graphics refer to mineral oil with a kinematic viscosity of 30 cSt. The variation of the pressure drop is proportional to viscosity.

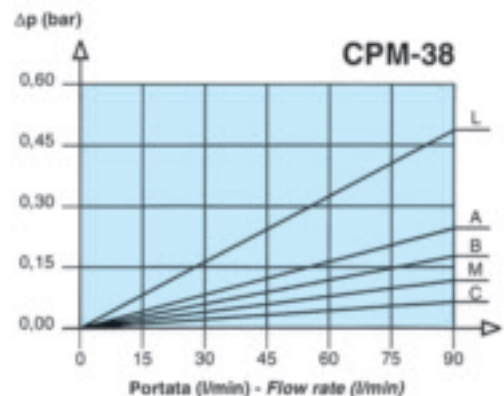
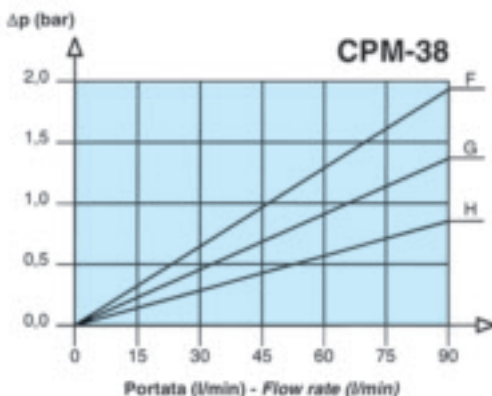
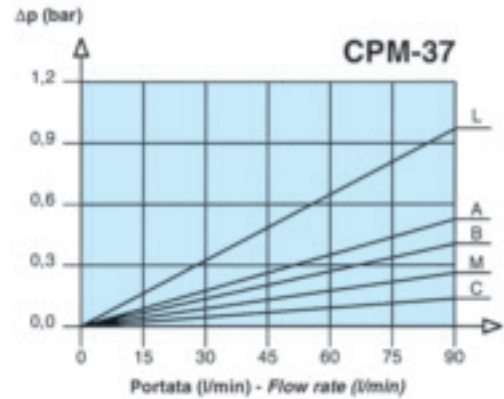

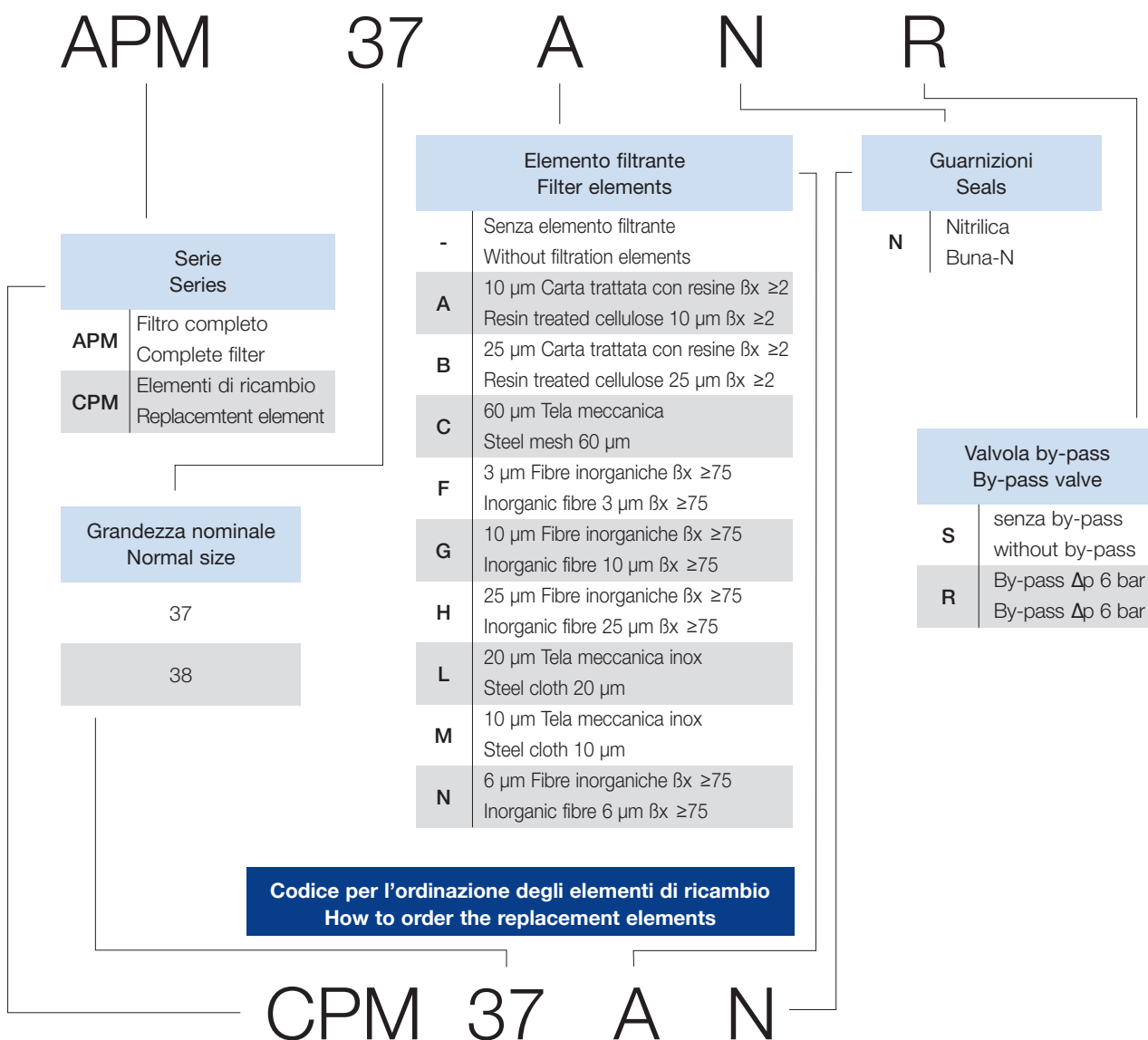

DESCRIZIONE

- Pressione massima di esercizio = 110 bar
- Pressione massima di collaudo = 220 bar
- Valvola by-pass, tarata a 6 bar
- Temperatura d'esercizio da -25°C a +110°C
- Compatibilità con oli idraulici verificata secondo ISO 2943
- Attacchi filettati gas cilindrico secondo UNI 388
- Testina e contenitore eseguite in alluminio temperato

- A,B. in microcarta trattata con resina stabilizzata con grado di filtrazione 10 e 25 micron βx ≥2
- C in rete metallica con grado di filtrazione 60 micron nominali
- F, G, H in microfibre inorganiche rinforzate con grado di filtrazione 3, 6, 10, 25 micron βx ≥75
- L, M in tela d'acciaio con gradi di filtrazione 10 e 20 micron
- Pressione differenziale di collasso 20 bar secondo ISO 2941
- Conformità di fabbricazione secondo ISO 2942
- Efficienza filtrante multipass-test secondo ISO 4572

DESCRIPTION

- Max. working pressure: 110 bar
- Max. test pressure: 200 bar
- By-pass valve setting to 6 bar
- Working temperature from -25°C to +110°C
- Compatibility with hydraulic oils tested as per ISO 2943
- BSP threads as UNI 388
- Head and body in alu-tempered alloy

- A and B in micropaper treated with resin stabilized filtration degree 10 and 25 micron βx ≥2
- C in steel with filtration degree 60 micron
- F and G and H in micro inorganic fibres, filtration 3, 6, 10, 25 micron βx ≥75
- L and M in steel with filtration degree 10 and 20 micron
- Differential collapse pressure 20 bar as per ISO 2941
- Produced as per ISO 2942
- Filtration efficiency multi-pass as per ISO 4572

A series of 25 horizontal light blue lines intended for writing notes.

SCAMBIATORI
HEAT EXCHANGERS

FILTRI
FILTERS

ACCESSORI
ACCESSORIES

COMPONENTI
COMPONENTS

FLANGE / FLANGES
RACCORDI / COUPLINGS
BLOCCHI / MANIFOLDS



OMIT