

OMIT



Filtri sfiati aria
Air filters

TSA

Filtro sfiato aria

Air filter



i filtri sfiato aria si montano sui serbatoi per filtrare l'aria che entra a compensazione della variazione di volume del fluido. Si montano inoltre sull'aspirazione di compressori e motori a scoppio.

Disponibili con attacchi filettati Gas.

Gli elementi filtranti sono rigenerabili in rete vellutata, con grado di filtrazione standard 40 Micron.

Air filters are mounted on oiltanks with the aim to filter the air.

They are also mounted in suction of compressors and engines.

Available with BSP threads.

Replace elements are regenerated in velvet net in 40 Micron.

Esempio codice di ordinazione - Ordering example

TSA 33 - 14

Serie
Series

| Tipo / Type |
|-------------|
| 33 |
| 50 |
| 70 |
| 107 |
| 135 |
| 166 |

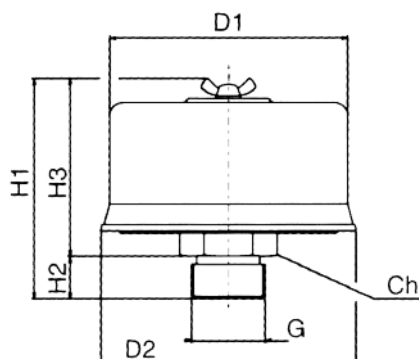

ATTACCHI / CONNECTIONS

| Codice Code | Portata /min | D1 | D2 | H1 | H2 | H3 | G | Ch |
|-------------------|-----------------|-----|-----|-----|----|-----|--------|----|
| TSA33-14 | 140 | 33 | 36 | 48 | 13 | 35 | 1/4" | 22 |
| TSA33-38 | 140 | 33 | 36 | 48 | 13 | 35 | 3/8" | 22 |
| TSA33-12 | 140 | 33 | 36 | 48 | 13 | 35 | 1/2" | 22 |
| TSA50-14 | 200 | 50 | 53 | 63 | 13 | 50 | 1/4" | 22 |
| TSA50-38 | 500 | 50 | 53 | 63 | 13 | 50 | 3/8" | 22 |
| TSA70-12 | 500 | 70 | 76 | 80 | 13 | 67 | 1/2" | 27 |
| TSA70-34 | 500 | 70 | 76 | 80 | 17 | 63 | 3/4" | 32 |
| TSA107-100 | 800 | 107 | 114 | 99 | 19 | 80 | 1" | 38 |
| TSA135-112 | 1500 | 135 | 143 | 132 | 25 | 107 | 1 1/2" | 55 |
| TSA166-212 | 2000 | 166 | 175 | 172 | 25 | 147 | 2 1/2" | 80 |

CSA

Filtro sfiato aria Air filter



i filtri sfiati aria serie CSA si montano sui serbatoi per filtrare l'aria che entra a compensazione della variazione di volume del fluido.

Sono costituiti da una cartuccia SPIN-ON da avvitare ad un supporto da saldare o flangiare al serbatoio.

Air filters are mounted on oiltanks with the aim to filter the air.

They are formed by a SPIN-ON replace element to screw to a support to be welded or to be flanged to the oil tank.

Esempio codice di ordinazione - Ordering example

CSA 05 A - S

Serie / Series

S a saldare / with flange
F con flangia / with flange

Elemento filtrante / Filtration elements

A Carta trattata con resine 10 micron / Paper treated with resins 10 micron
B Carta trattata con resine 25 micron / Paper treated with resins 25 micron

| Dimensioni cartuccia / Dimensions | | | |
|-----------------------------------|------------|-----|-----|
| Codice Code | D1 | D2 | H1 |
| 05 | 3/4" BSP | 98 | 145 |
| 06 | 3/4" BSP | 98 | 165 |
| 10 | 1 1/4" BSP | 132 | 180 |
| 15 | 1 1/4" BSP | 132 | 205 |

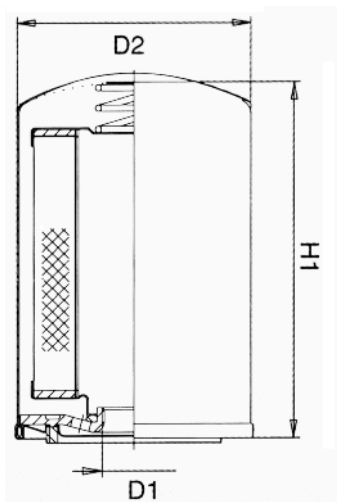

per / for
CSA05 - 06

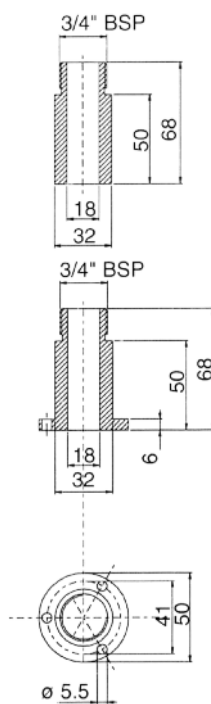

per / for
CSA10 - 15

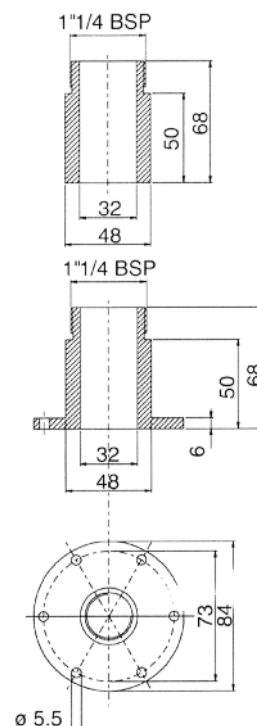

SCAMBIATORI
HEAT EXCHANGERS

FILTRI
FILTERS

ACCESSORI
ACCESSORIES

COMPONENTI
COMPONENTS

FLANGE / FLANGES
RACCORDI / COUPLINGS
BLOCCHI / MANIFOLDS

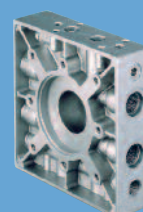
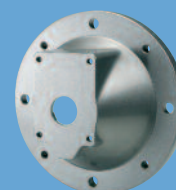
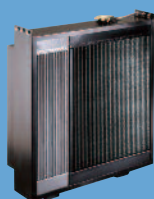
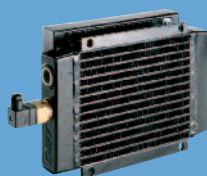

OMIT